

Installation Information

Item #P1022

Exposed Shower Set with 7" Centers

Warranted only if installed by a qualified licensed plumber.

1. Shut off the water supply before installation.
2. Rough-in $\frac{1}{2}$ " Male IPS with $\frac{1}{2}$ " of threads past the finished wall at 7" centers.
3. Thread on the straight wall mount couplers to the $\frac{1}{2}$ " nipples extending out from finished wall, use Teflon paste or tape.
4. Connect the main valve body to the wall mount couplers.
5. Thread the shower arm into the 90 degree ball elbow using a clear two part epoxy.
6. Thread the 36" riser into the ball elbow using a clear two part epoxy. Insert the riser into the valve body and tighten the compression nut to seal the riser connection.
7. Attach the wall bracket escutcheon to the wall at desired height. Wall support may need to be cut to length, cut non-threaded end only. Secure to riser with the c-clamp provided.
8. Attach shower head to the shower arm using Teflon paste or tape.

Parts Included:

- (1) Thermostatic valve body
- (1) 36" Riser
- (1) 12" Wall Support
- (1) 90 degree Ball Elbow
- (1) Shower Arm
- (1) Shower Head

NOTE:
THIS UNIT IS NOT WARRANTED FOR
OUTDOOR USE.

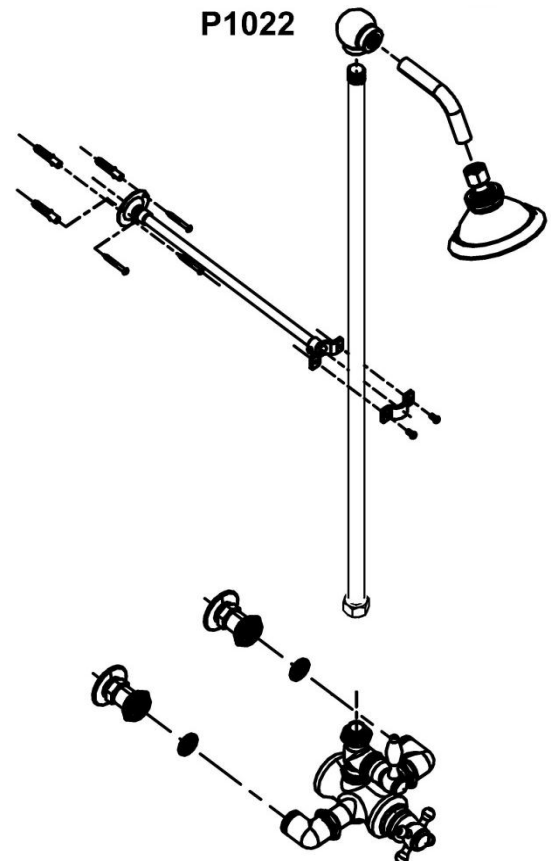

This faucet is tested to remain within 1 degree Fahrenheit of your desired setting throughout its operation, with an automatic temperature stop at 104 degrees Fahrenheit. The unit also has a built-in anti-syphon.